

01



/ kg/ . m kg/ . m kg/ . m



mm



mm* mm



02

/SPECIFICATIONS

	ER -
	kg
	± . mm
	kg
	mm
	IP / IP
	IP / IP
	AC

	J	N m
	J	N m
	J	N m
	J	. kg m ²
	J	. kg m ²
	J	. kg m ²
	J	°/sec
	J	°/sec
	J	°/sec
	J	°/sec
	J	°/sec
	J	°/sec
	J	± °
	J	+ °/- °
	J	+ °/- °
	J	± °
	J	± °
	J	± °

/OPERATING SPACE

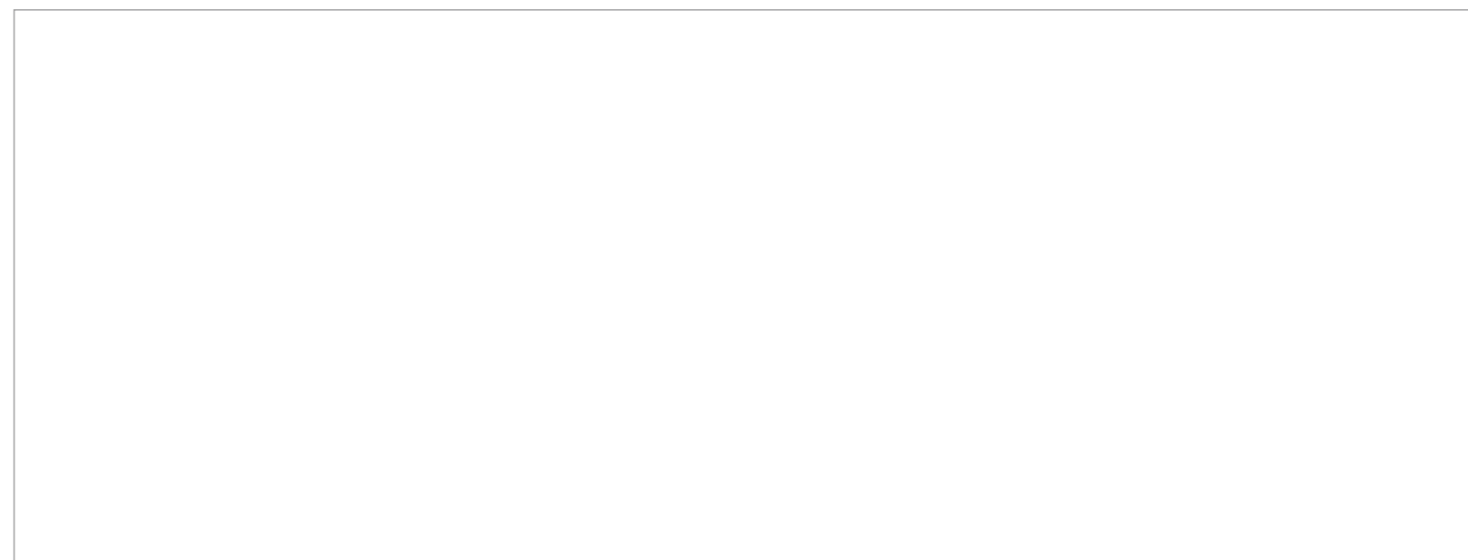

/BASE MOUNTING SIZE

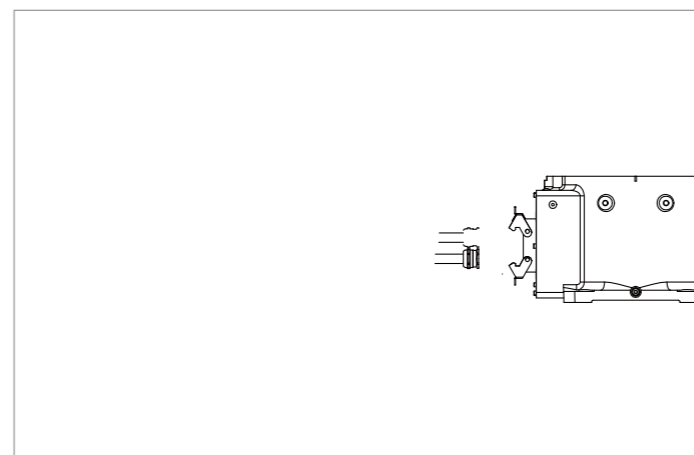

/END FLANGE MOUNTING SIZE

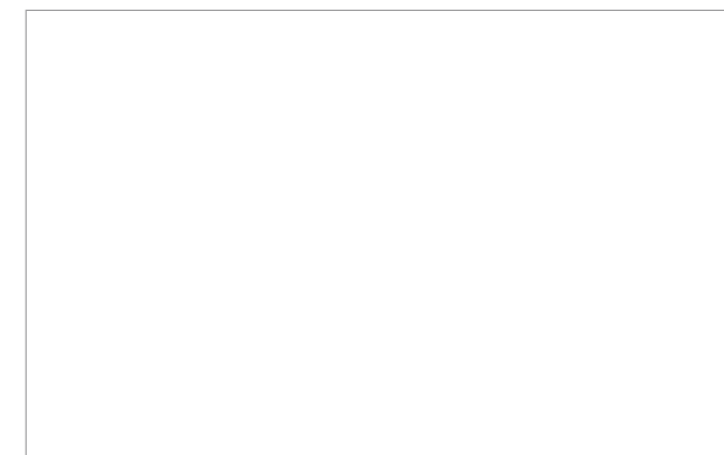

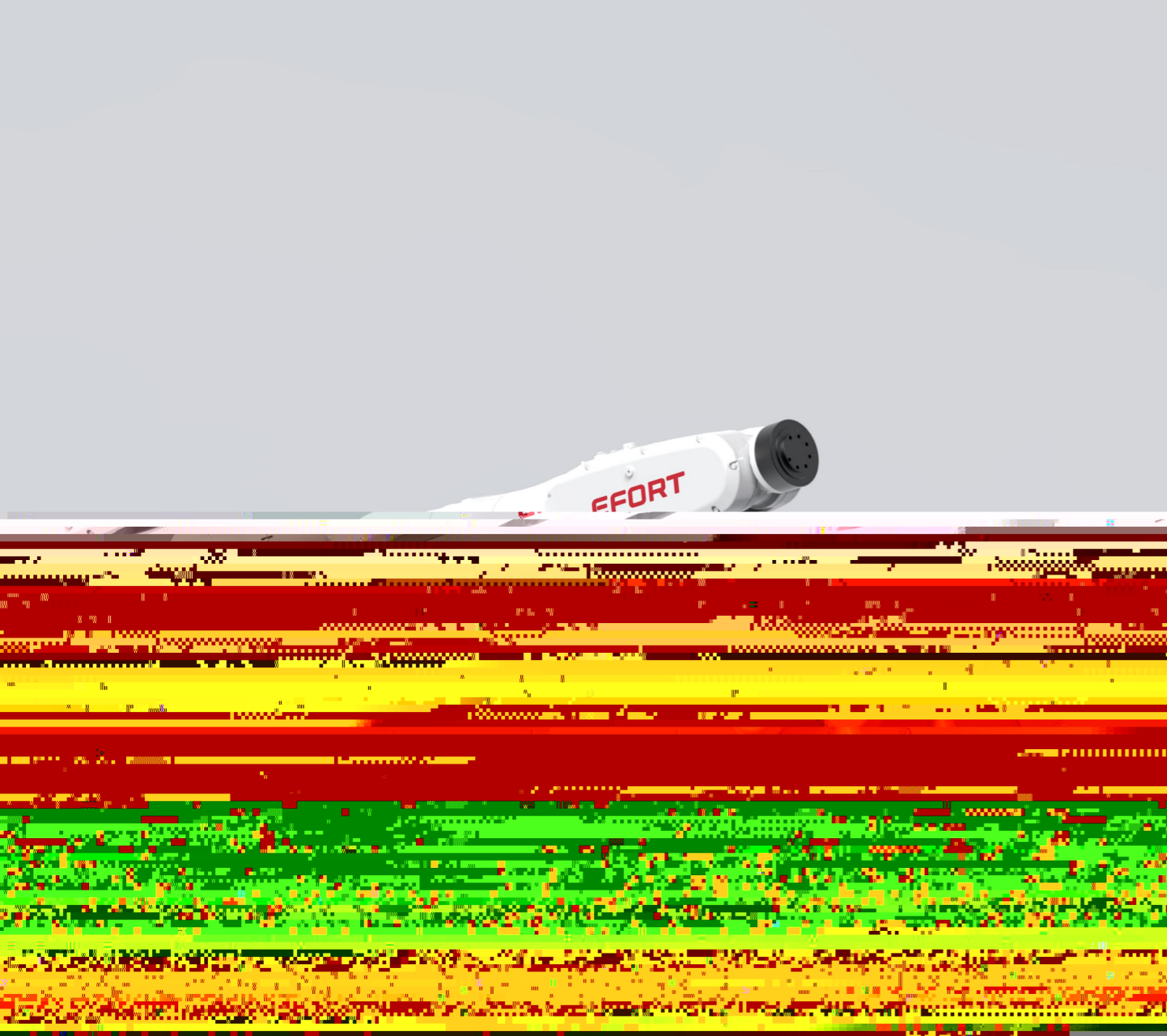

/SPECIFICATIONS

	ER -
	kg
	± . mm
	kg
	mm
	IP / IP
	IP / IP
	AC

J	
J	
J	N m
J	. kg m ²
J	. kg m ²
J	. kg m ²
J	°/sec
J	°/sec
J	°/sec
J	°/sec
J	°/sec
J	°/sec
J	± °
J	+ °/- °
J	+ °/- °
J	± °
J	± °
J	± °

/OPERATING SPACE

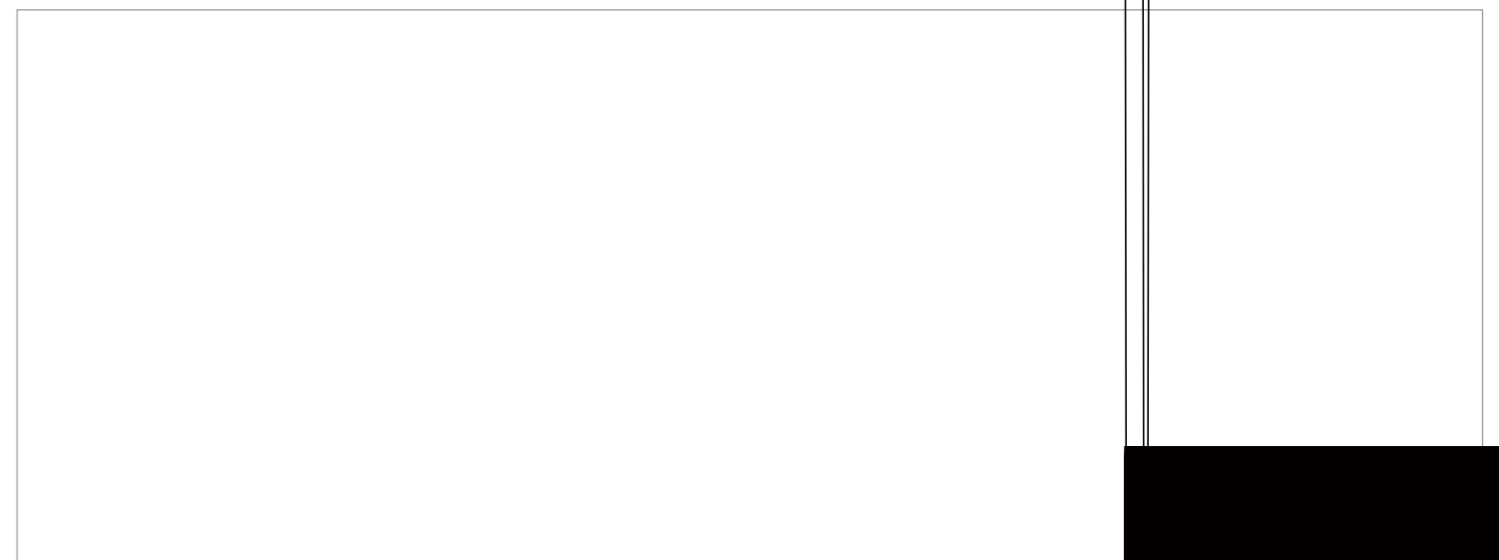

/BASE MOUNTING SIZE

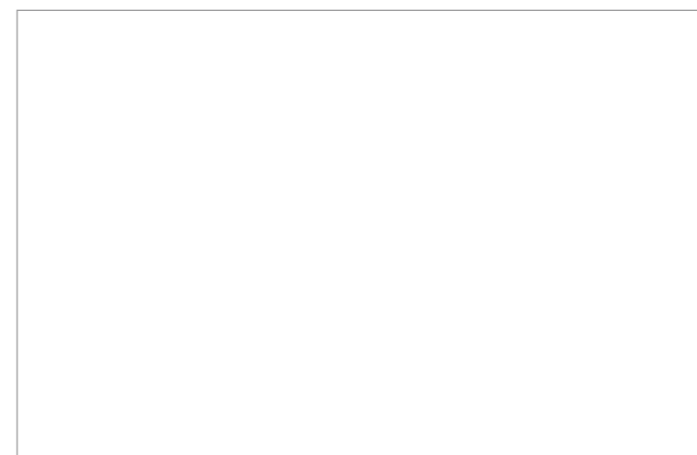

/END FLAN

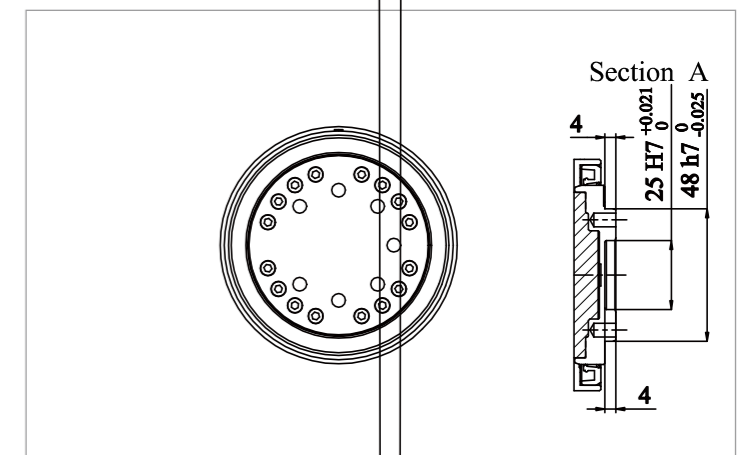



/SPECIFICATIONS

	ER -
	kg
	± . mm
	kg
	mm
	IP / IP
	IP / IP
	AC

J	N m
J	N m
J	N m
J	. kg m ²
J	. kg m ²
J	. k m ²
J	°/sec
J	°/sec
J	°/sec
J	°/sec
J	°/sec
J	°/sec
J	± °
J	+ °/- °
J	+ °/- °
J	± °
J	± °
J	± °

/OPERATING SPACE

--	--